

# High-Efficiency, High-Gain Power Amplification for PCS

Dr. Chance M. Glenn, Sr. – *Founder and CTO*  
 Syncrodyne Systems Corporation  
 Columbia, MD  
 410-964-3326 – phone  
 410-964-0364 – fax  
 chance.glenn@syncrodyne.com - email

**Abstract** – *The next generation of mobile telecommunications systems will continue to integrate higher level computing functions, thus increasing the power demand of the device by virtue of increasing the throughput, and increasing on-time. The development of battery technology has not kept up with needs of the industry, therefore OEMs can only maintain their competitive edge in terms of cost, size, functionality, and features, by utilizing the source power more efficiently. In this paper we describe a new concept in power amplification, called syncrodyne amplification, which uses fundamental properties of chaotic oscillators to provide high-efficiency, high gain amplification of standard communication waveforms. We show results of this system providing nearly 60-dB power gain and greater than 70% PAE for communications waveforms conforming to GSM modulation. Finally we show results from a modeled syncrodyne amplifier design operating in the 824 -850 MHz (PCS) band utilizing heterojunction bipolar transistors (HBTs).*

## Introduction

In this paper we introduce formally and demonstrate experimentally, a new method of high-gain, high-efficiency power amplification of standard communication waveforms using a chaotic process. We show that this process, called *syncrodyne amplification*, is capable of operating on communication waveforms such as GSM and CDMA and capable of providing gains in excess of 60 dB and power added efficiencies greater than 70%.

In a general sense, the goal of this work is to provide evidence of the notion that the application of chaotic dynamics to engineering technology can provide significant advantages over traditional design. Our goal is to provide a solid example of such an advantage.

We will show experimental results for a 2 MHz prototype, show modeling results for a 150 MHz design, and finally show results for a chaotic oscillation at 850 MHz with the goal of developing a circuit viable at PCS frequencies.

## The Future of the Telecommunications Industry

The communications industry has squarely trained its focus on wireless technology. Even though there has been a significant down-turn in the past year or so in this industry, there still remains significant optimism as consumer demand for new features and the integration of current features continues to grow [1]. Table 1 below shows world mobile handset

subscribers, past, present, and projected through 2005, having a compound annual growth rate of 16.5%. Regardless of the commercial climate, there is a large, ever-evolving market for wireless communications.

Table 1. Mobile Handset Market: Mobile Subscriber Forecast (World), 1999 – 2005.

Year	Subscribers (Million)	New Additions (Million)	Subscriber Growth Rate (%)
1999	477.5	159.5	-
2000	722.0	244.5	51.2
2001	943.3	221.3	30.7
2002	1,151.5	208.2	22.1
2003	1,363.6	212.1	18.4
2004	1,560.1	196.5	14.4
2005	1,739.0	178.9	11.5
CAGR			16.5%

CAGR = Compound Annual Growth Rate (2001-2005)

One of the greatest challenges for the mobile wireless communications industry has been the provision of mobile power sources capable of meeting the growing demand by users. Improvement and integration of features in mobile handsets increase on-time, and processor requirements, all placing higher demand on the battery. According to Frost & Sullivan, the development of battery technology, specifically its energy storage capacity, has not kept

up with the demand by the mobile wireless industry [2].

The solution to this dilemma lies in the efficient utilization of the power provided. In mobile communications the power amplifier uses the bulk of the supply power. Table 2 shows a survey of the leading power amplifier products and the performance of their products. For a power amplifier, power-added efficiency (PAE) is defined by  $PAE = \frac{P_o - P_{in}}{P_{dc}}$ , where  $P_o$  is the output power,

$P_{in}$  is the input power, and  $P_{dc}$  is the power delivered by the dc source. As shown by the table, efficiencies tend not to exceed 40% in practice. This wasted energy, often in the form of heat, is due to employment of inefficient linear design techniques in order to meet the strict spectral requirements of the industry.

Table 2. Summary of performance parameters for the leading PA products.

	Raytheon	RF Micro Devices	IBM	Sirenza
Part	RMPA 0951A-102	RF2162	2018M009	SPA-2118
Gain	30 dB	29 dB	28 dB	32.5 dB
PAE	30%	35%	34%	38%

### Chaotic Dynamics

Since Ott, Grebogi and Yorke's paper in 1990 there has been a tremendous push for the application of chaotic dynamics to technology [3]. Like other endeavors of the 90's many a student, professor and entrepreneur rushed to this area to find what gems lie there. Technology companies have been established, employing researchers in chaotic dynamics in order to find important links to commercial technology. Applications ranging from the control of fluid dynamics, weather prediction and control, spacecraft guidance, sensors and detection, and control of lasers, to various facets of communications have been studied and in some cases put into practice.

By far, the most intriguing and sought after application of chaotic dynamics is in the area of communications. In 1993 Hayes described a formal linkage between chaotic dynamics and information theory [4], showing that the *symbolic dynamics* of a chaotic system could be controlled, thereby paving the way for the direct

encoding of digital information into a chaotic oscillation [5]. Figure 1 shows the oscillations of a typical chaotic oscillation encoded to produce a pre-described digital sequence.

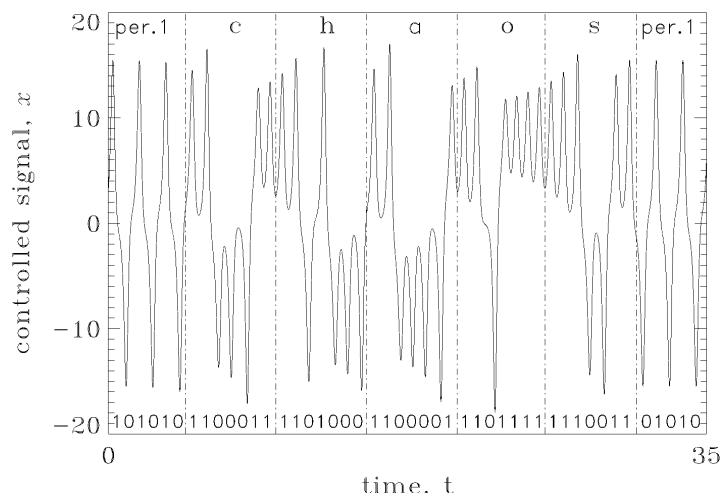

Figure 1 Lorenz oscillations encoded to carry a digital sequence which produces the ASCII text 'c-h-a-o-s'.

It is well known that the operation of electronic circuits and devices in the strongly nonlinear regions yields higher power conversion efficiency [6]. The heart of chaotic dynamics is its operation in the nonlinear regions of the system. Figure 2 shows a typical I-V characteristic curve for a typical transistor. Traditional designers bias their circuit such that the transistor will operate in the linear

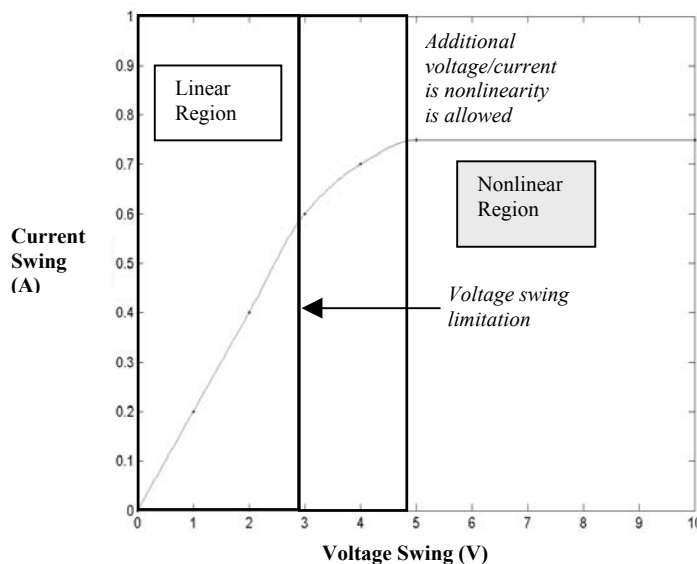

Figure 2 A typical I-V characteristic curve for a transistor describing the linear and nonlinear regions of operation.

region. This type of operation limits the output voltage swing of the circuit. Although the circuit may be capable of producing output voltages outside of the linear region of the transistor, the circuit is purposely designed to avoid this in order to suppress the generation of harmonics. Circuits that are designed to operate in the nonlinear region of the transistor's operation are capable of broader output voltage swings and even higher current, thus capable of higher output power, thus capable of higher power conversion efficiency.

Chaotic oscillations occur as a result of operating the system in its nonlinear state. This is not to say that all nonlinear operation results in chaos, only that the system must be nonlinear in order for chaos to exist.

In the following section we will consider the Colpitts oscillator as the basis of our implementation of synchrodyne amplification. There are three fundamental reasons why we choose this particular oscillator. The first reason is that the Colpitts configuration has been a staple of communications electronics for years. Most analog electronic circuits that require sinusoidal signals employ Colpitts-type circuits. Figure 3 is the Colpitts circuit used for this analysis. Note the feedback is a tank circuit consisting of an inductor and two capacitors. The

resonant frequency is given by  $\omega = \sqrt{\frac{C + C_e}{LCC_e}}$ .

The circuit equations are,

$$L \frac{di_L}{dt} = V_{CC} - v_c - (R + R_L)i_L$$

$$C_e \frac{dv_e}{dt} = i_L - \frac{v_e - V_{EE}}{R_e}$$

$$C \frac{dv_c}{dt} = C \frac{dv_e}{dt} + i_L - i_c$$

where  $i_c$  is the forward transistor collector current defined by  $i_c = \gamma(e^{-\alpha v_e} - 1)$ ,  $\gamma$  and  $\alpha$  are empirically derived factors for the transistor and  $R_L$  is the series resistance of the inductor.

The second reason for choosing the Colpitts oscillator is apparent from both the circuit mathematical expression and the circuit schematic diagram. The Colpitts circuit is a simple circuit easily modeled, easily realized, and scaleable in frequency. These are critical factors in considering this type of architecture for practical, commercial technology.

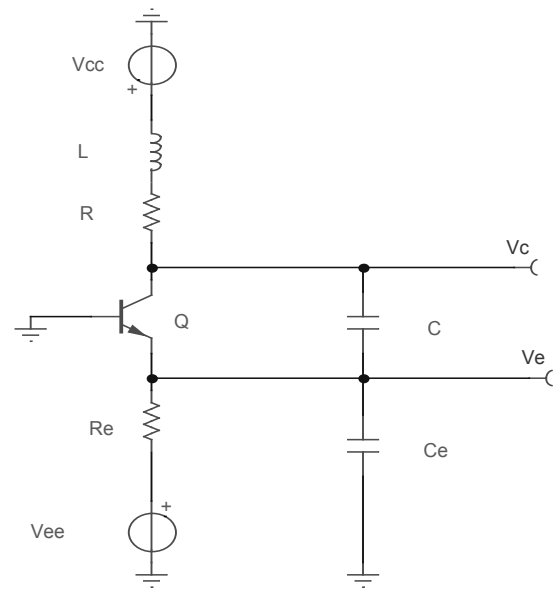

Figure 3. Transistor based Colpitts oscillator circuit used for this analysis.

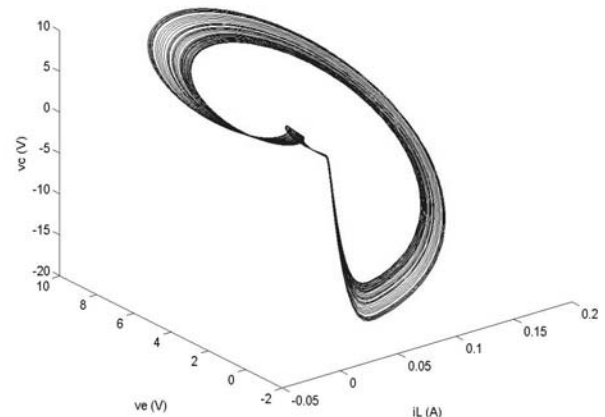

Figure 4 Three-dimensional representation of the state-space trajectories for the Colpitts oscillator illustrating the

The third reason is that in general the chaotic dynamics produced by this oscillator are well understood. There are parameter sets that produce chaotic oscillations of a Rössler type. Once such set of parameters are: [ $V_{cc} = 5V$ ,  $V_{ee} = -5V$ ,  $C = 1.6$  nF,  $C_e = 1.8$  nF,  $L = 6.8$   $\mu$ H,  $R = 62.5$   $\Omega$ ,  $R_L = 2\Omega$ ,  $R_e = 260\Omega$ ,  $\gamma = 1.06 \times 10^{-15}$ ,  $\beta = 41.2$ ]. These parameters produce chaotic oscillations that have a dominate frequency about 2 MHz. Figure 4 shows a three-dimensional plot of the solutions of the state equations for the circuit utilizing these parameter values. The object formed is what is termed a *state-space attractor*, and is a *strange attractor*, in that it

has *fractal* dimension [7].

Figure 5 shows the power spectrum for  $v_c$ . Here we see the broad spectral content typical of chaotic oscillations. The calculated resonant frequency for the circuit, using the equation above, was 2.1 MHz.

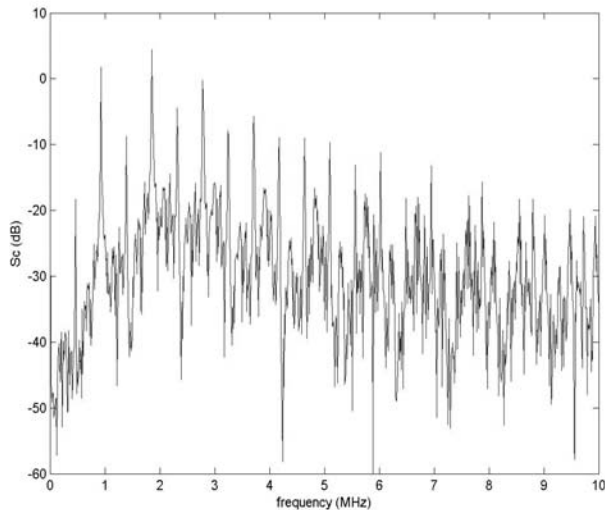

Figure 5 Power spectrum of the collector voltage for the Colpitts oscillator in a chaotic mode of operation.

### Synrodyne Amplification

The synrodyne amplifier based on the concept of signal amplification using **synchronous dynamics**. Synrodyne amplification is the process of locking a chaotic oscillator, larger in power, to a smaller, continuous-time, information-bearing oscillator through a process called *synchronization* [8]. The smaller oscillator is called the guide signal. The continuous-time guide signal has the advantage of only needing to guide one state variable. The guide signal need only supply a small amount of power to the "amplifying oscillator" in order to stabilize its dynamics. Figure 6 shows a simple block diagram of a synrodyne amplifier. As synchronization occurs, the error signal,  $e(t)$  goes to zero.

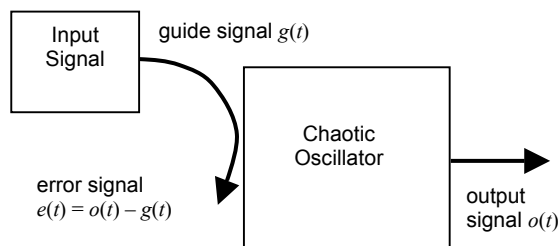

Figure 6 Block diagram of a synrodyne amplifier system.

This error is directly related to the current flow from the guide system to the output oscillator. As the current goes to zero the power flow from guide to output goes to zero and power amplification occurs.

Since the chaotic system is operating in the nonlinear region of operation it is more efficient. Further, we found that this high-efficiency, high-gain process worked for guide signals that were non-chaotic. The guide signal can be phase modulated sinusoidal oscillations such as phase shift keying (PSK), quadrature phase shift keying (QPSK), minimal shift keying (MSK) and even more sophisticated communications signal formats applicable to the global system for mobile communication (GSM) and code-division multiple access (CDMA). This leads to the application of this technique to standard digital communications technology, offering the possibility of high-gain, high efficiency power amplification.

### Development

In the broader development plan for the synrodyne amplifier we have approached it in the following manner:

- (a) Series-2: Low frequency (2 MHz) mathematical model.
- (b) Low frequency circuit fabrication and testing.
- (c) Series-3A: Mobile, mobile-satellite band (150 MHz) SPICE model and analysis using a SiGe heterojunction bipolar transistor (HBT).
- (d) Series-3A circuit design, fabrication and testing.
- (e) Series-3B: Land-mobile band (450 MHz) SPICE model and analysis.
- (f) Series-3B circuit design, fabrication and testing.
- (g) Series-3C: PCS frequency (824-850 MHz) model.
- (h) Series3C frequency circuit design, fabrication and testing.
- (i) Series-4: Microwave frequency development.

Our goal is to produce devices in the relevant frequency bands identical in form, fit, and function to present power amplifier products. It is important to determine the frequency scaling characteristics so to provide a complete picture of this concept. Viable markets exist for the Series-3A and 3B devices as we prepare to push this technology to industry.

This paper reports on the results of (a), (b), and (c) while showing a basis for (e), (g) and beyond.

### Series-2 Results

We fabricated a Colpitts-based synrodyne amplifier and drove it with a 650 bps, 0.3 GMSK modulated

waveform with a 2 MHz carrier frequency. This was done to mimic the specifications of an 824 MHz – 850 MHz GSM waveform [9]. Figure 7 shows the frequency spectrum of the input waveform.

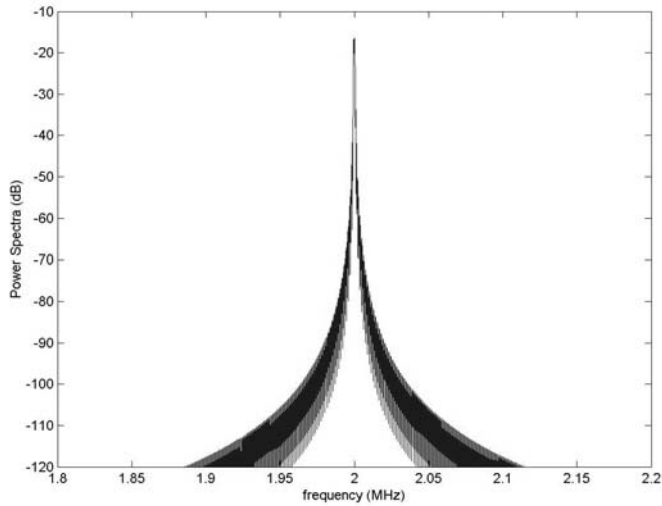

Figure 7. the power spectrum of the 2 MHz GSM input waveform.

We took measurements of the maximum power gain and the power-added efficiency and compared it with the anticipated results from the computer model. Figure 8 shows the comparison of the modeled and measured relationship of the power gain and the PAE.

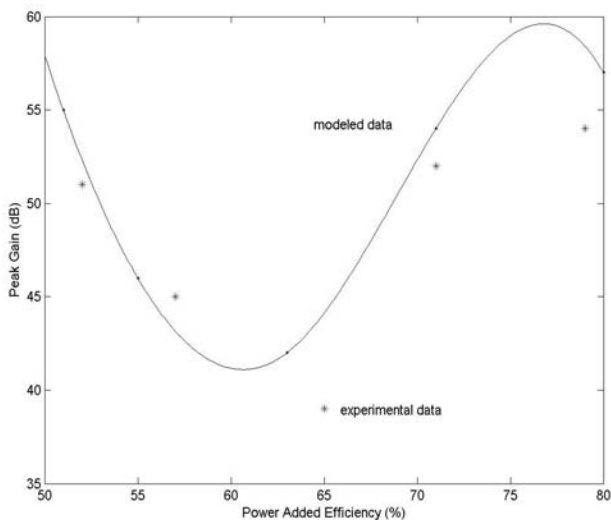

Figure 8. Comparison of experimental data from the 2 MHz syncrodyne amplifier with modeling results.

We see a device capable of delivering enormous power gain and very high efficiency. There was good agreement with the results of the model as compared with the experimental results. We found both experimentally and through the model, that the capacitor C provided an excellent means for tuning the circuit in order to maximize the gain and efficiency when input conditions change. For example, when the peak-to-peak voltage of the input signal changes the circuit must be tuned. Figure 9 shows this response. This provides design guidance in order to achieve maximum performance. Figure 10 shows the output frequency response for a 2 MHz sinusoidal input used to characterize the system. Note that the harmonics occur below -45 dB.

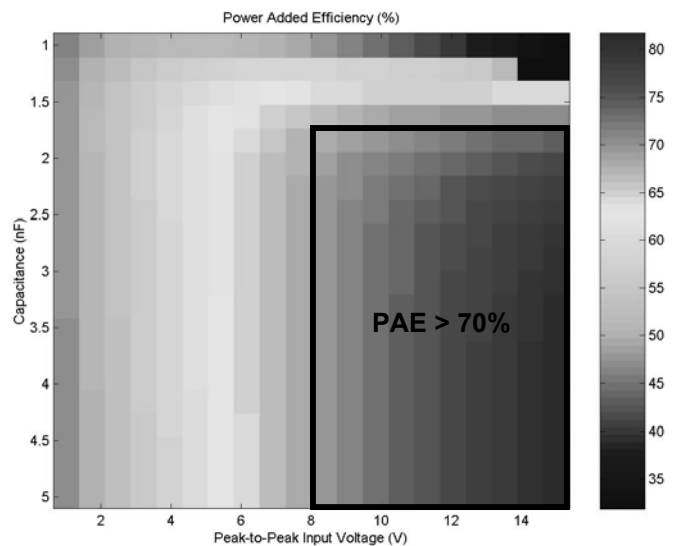

Figure 9. Surface map illustrating the PAE for peak-to-peak input voltages and tuning capacitance values.

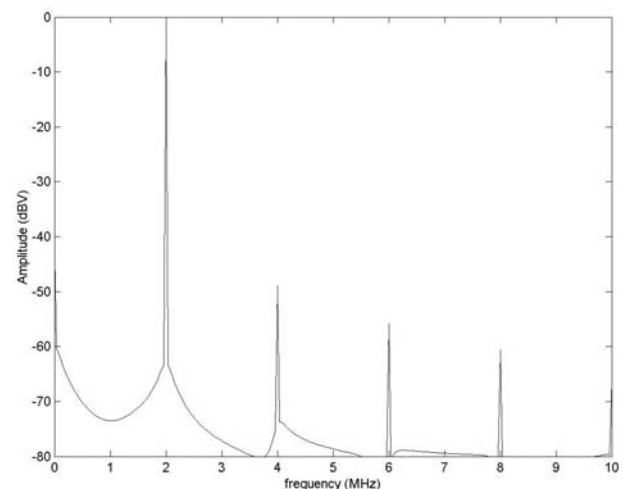

Figure 10. Output frequency response for a 2 MHz sinusoidal input. Note harmonics below -45 dB.

**Series-3A SPICE model**

Figure 10 shows a general block diagram for a syncrodyne amplifier. An important component of this system is the optimization/stabilization block. In practice, this is a feedback mechanism that senses the error between the input and the output signals and applies perturbations to a circuit element to minimize this error in real-time. The series-2 modeling stage showed that minimization of this error can be achieved by tuning a capacitance, and that this worked to maximize the efficiency and gain.

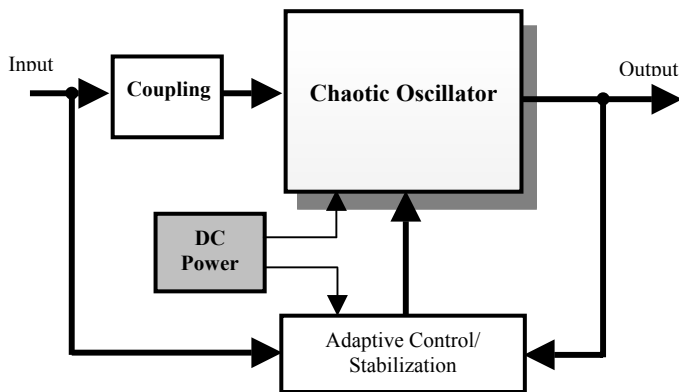

Figure 10. General syncrodyne amplifier block diagram.

The key design goal for syncrodyne amplification is to first produce chaotic oscillations at the frequency band of interest. We use the Colpitts oscillator as a basis for circuit architecture. Figure 11 shows the schematic diagram for the circuit model. We were able to incorporate modeling parameters for a Sirenza sga-8343 HBT while building this model to incorporate specific models for each obtainable circuit element. Some of the devices are tunable so that true operating points could be attained

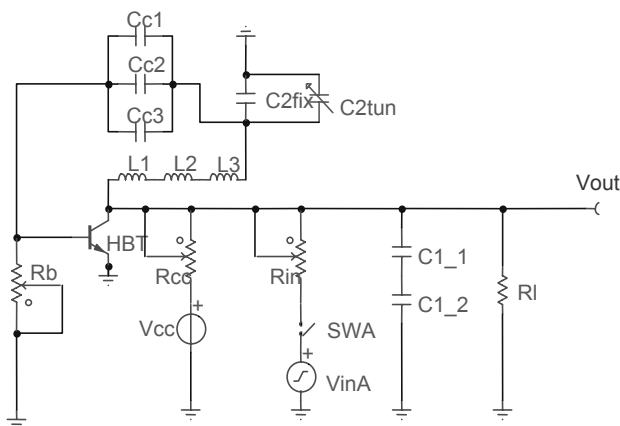

Figure 11. Series-3A syncrodyne amplifier schematic diagram for SPICE model

Figure 12 shows (a) the output frequency spectrum of the oscillator when the switch is in the off position and (b) when the switch is turned on. When switched off, the circuit is a free-running chaotic oscillator with oscillations centered about 154 MHz having about a 25 MHz bandwidth. This broad-banded behavior is typical of chaotic oscillators. When the switch is turned on the oscillator locks to the sinusoidal drive oscillation. This system produced a gain of a over 50 dB and was about 76% efficient. We believe that these numbers can be improved upon by judicious choice of circuit elements and the balancing of the operating point of the circuit for stronger chaotic oscillations.

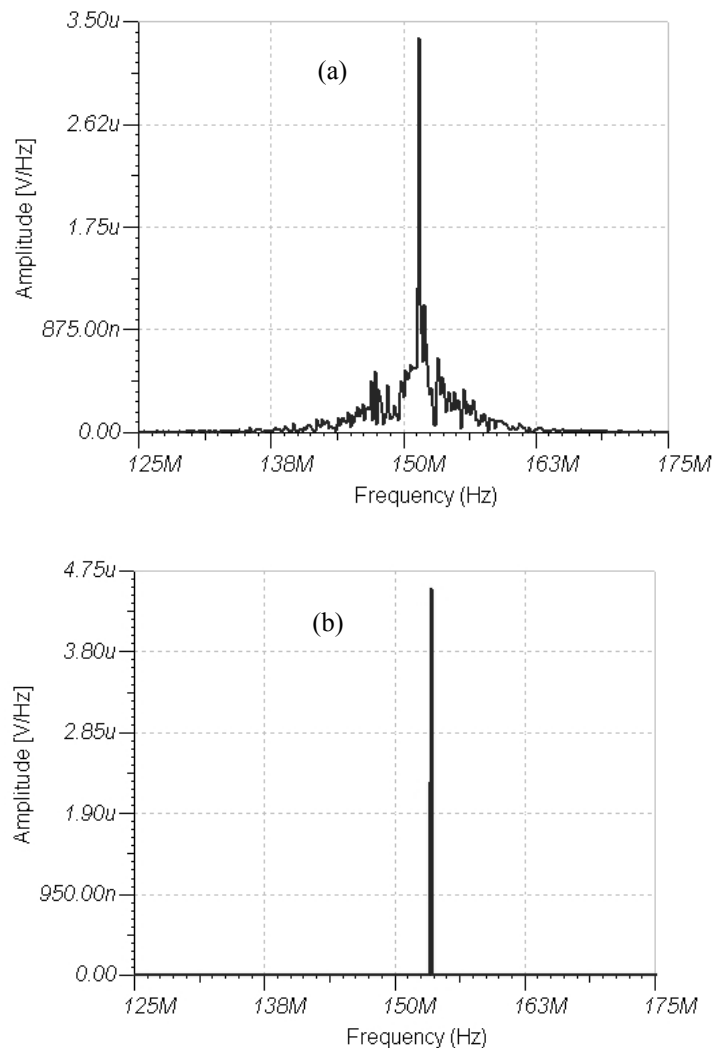

Figure 12. Frequency spectrum of the output signal of the Series-3A syncrodyne amplifier model when (a) the switch is off and (b) on.

The optimization/stabilization portion of this circuit will replace the tuning capacitance,  $C_{2\text{tun}}$ , and will incorporate a varactor diode balanced for the proper capacitance tuning range.

### Series-3B/3C Design Preparation

We have begun this process by identifying circuit architectures and parameter values that lead to chaotic oscillations around 824 MHz. In figure 13 we show a state-space plot of the voltage across one of the circuit capacitances versus the inductor current. This is a typical method of displaying a chaotic oscillation, called a state-space plot [11]. This is only a 2-dimensional projection of the true state-space. The Colpitts-based transistor circuit was modeled with a SPICE simulator using the Sirenza sga-8343 HBT. The oscillation frequency was 849 MHz with a 50 MHz bandwidth.

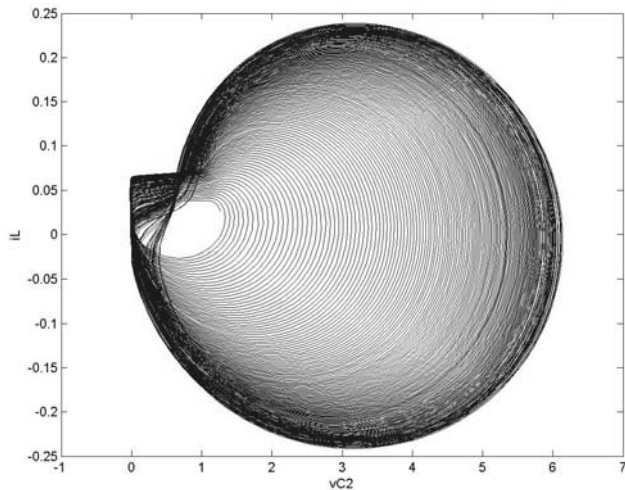

Figure 13. 2-dimensional projection of the state-space of an 850 MHz chaotic oscillation.

### Conclusions

Syncrodyne amplification is a new concept in power amplifier implementation. It is not amplification in the traditional sense. It uses fundamental aspects of chaotic dynamics, sensitivity to small changes, synchronization, and the natural efficiency that can result from operating a device in its nonlinear region, to derive its operation. Essentially, linear amplification is provided through nonlinear means.

Our development path is taking us into the realm of PCS frequencies and beyond. Chaotic dynamics has been observed and reported on in the microwave frequency range [10]. It is obvious the many benefits that can result from more efficient power utilization.

Devices become smaller, cheaper, operate longer, and transmit further and faster. These and other benefits are critical to the communications industry in both commercial and military sectors.

We have been able to report on successful results up to 150 MHz and preliminary results towards PCS frequencies.

---

*This work constitutes proprietary technology developed by Syncrodyne Systems Corporation. All rights reserved.*

*Chance M. Glenn, Sr. is a co-founder and chief technology officer for Syncrodyne Systems Corporation in Columbia, MD. He received his bachelors degree in electrical engineering from the University of Maryland at College Park, his Master's and Ph.D. degrees in electrical engineering from The Johns Hopkins University.*

### References

- [1] Frost & Sullivan, *2001 World Handset RF-Semiconductor Markets*, January 2002.
- [2] Frost & Sullivan, *Mobile Telecommunications Markets – 2<sup>nd</sup> Quarter 2001*, July 2001.
- [3] E. Ott, C. Grebogi, J. A. Yorke, *Phys. Rev. Lett.* **64**, 1196 (1990).
- [4] S. Hayes, C. Grebogi, E. Ott, *Phys. Rev. Lett.* **70**, 3031 (1993).
- [5] S. Hayes, C. Grebogi, E. Ott, A. Mark, *Phys. Rev. Lett.* **73**, 1781 (1994).
- [6] S. M. Sze, *High-Speed Semiconductor Devices*, AT&T Bell Laboratories, John Wiley & Sons, New York, 1990.
- [7] Martin J. Hasler, *Electrical Circuits with Chaotic Behavior*, Proceedings of the IEEE, vol. 75, no. 8, August 1987.
- [8] L. M. Pecora and T. L. Carroll, *Synchronization in Chaotic Systems*, *Phys. Rev. Lett.* **64**, 821 (1990).
- [9] Theodore S. Rappaport, *Wireless Communications: Principles & Practice*, Prentice Hall, New Jersey, 1996.
- [10] C. M. Glenn, S. Hayes, *Observation of Chaos in a Microwave Limiter Circuit*, IEEE Microwave and Guided Wave Letters, vol. 4, no. 12, December 1994.
- [11] Edward Ott, *Chaos in Dynamical Systems*, Cambridge Univ. Press, Canada, 1993.

